

Neo-Dyn® Series 100P Pressure Switch/Internal Adjustment

Versatile Nega-Rate® Belleville disc spring pressure switch for use in hazardous areas. Series 100P (diaphragm sensor) for pneumatic and low impulse hydraulics up to 3000 psig system pressure.

Operating Pressure Data

Adjustable Range Number	Adjustable Set Point Range		Deadband (approximate)	Maximum Recommended System Pressure	Proof Pressure
	Increasing	Decreasing			
1	5 to 75	2.3 to 72.3	2.7	600	1000
2	15 to 150	9 to 144	6	3000	5000
4	50 to 300	36 to 286	14	3000	5000
5	125 to 600	100 to 575	25	3000	5000
7	500 to 1500	440 to 1440	60	3000	5000
8	800 to 2800	675 to 2675	125	3000	5000

All values given in psig.

Standard Specifications

Electrical

Snap action electrical switch assembly listed by Underwriters' Laboratories, Inc., Factory Mutual and CSA International

Electrical Connection

½ NPT male conduit connection with PVC insulated 18 AWG, 18" long leads

Pressure Connection

Wetted Material 1
¼ NPT Female

Wetted Material 4, 5, 7 and 9
½ NPT Female

Temperature Range*

Ambient: -40°F to +180°F
(-40°C to +82°C)

Media: -40°F to +300°F
(-40°C to +149°C)

*Temperature limits change with O-Ring selection. See Electrical Assembly specification sheet for Temperature Class Ratings.

Adjustment

Concealed wrench flat adjustment with range scale

Shipping Weight

Approximately 3 pounds

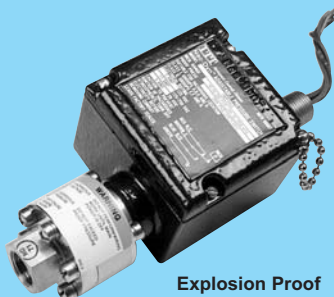

Explosion Proof
Hermetically Sealed
(NEMA 4X, 7, 9 and 13)

Ordering Sequence — Select desired option for each category

OPTIONS

Wetted Material

- 1 Aluminum port, Teflon coated polyimide diaphragm and Buna-N O-Ring
- 4 316 stainless steel port, Teflon coated polyimide diaphragm and Buna-N O-Ring
- 5 316 stainless steel port and diaphragm, heliarc welded
- 7 Hastelloy C port and diaphragm, heliarc welded (Except Range 1)
- 9 Monel port and inconel diaphragm, heliarc welded (Except Range 1)

Adjustable Range

- 1 2.3 psig dec. to 75 psig inc. (0.2 bar dec. to 5.2 bar inc.)
- 2 9 psig dec. to 150 psig inc. (0.6 bar dec. to 10.3 bar inc.)
- 4 36 psig dec. to 300 psig inc. (2.5 bar dec. to 20.7 bar inc.)
- 5 100 psig dec. to 600 psig inc. (6.9 bar dec. to 41.4 bar inc.)
- 7 440 psig dec. to 1500 psig inc. (30.3 bar dec. to 103.4 bar inc.)
- 8 675 psig dec. to 2800 psig inc. (46.5 bar dec. to 193.1 bar inc.)

Electrical Form

- C 11 amp, ¼ hp at 125 or 250 VAC; 5 amp resistive, 3 amp inductive at 28 VDC
.5 amp resistive at 125 VDC
- CC 11 amp, ¼ hp at 125 or 250 VAC; 5 amp resistive, 3 amp inductive at 28 VDC
.5 amp resistive at 125 VDC

Enclosure

- 6 Explosion proof, hermetically-sealed electrical assembly, leads factory sealed, P/N 057-0770 (C Form) and P/N 057-0771 (CC Form); **Underwriters' Laboratories, Inc.** listed (File E56677), **CSA International** certified (File LR34146), and **Factory Mutual** approval (File J.I.1R5A9.AE) for Division 1 and 2; Class I, Groups A, B, C and D; Class II, Groups E, F and G Hazardous Locations; NEMA type 7 and 9.

Miscellaneous

- A Epoxy paint exterior — extra protection for severe environments
- B Viton O-Ring
- C EPR O-Ring
- E ¼ - 20 SAE Female Port (wetted material 1 only)
- F Fire fuse — for fire-tested equipment (wetted materials 4 and 5 only)
- I ¾ NPT conduit box with terminal strip (Groups C & D only, not available with N option)
- J Annealed stainless steel port screws for H₂S environments (wetted materials 4 and 5 only, Consult factory for reduced system and proof pressures)
- M Gold electrical contacts for extremely low current applications
- N ATEX approval with CE Mark
- R 72" electrical free leads
- S Stainless steel diaphragm (wetted material 4 only)
- W Stainless steel screws — exterior (standard with wetted materials 4, 5, 7 and 9)
- Y 2" NPT Male port for viscous medias. Port Material is carbon steel (Wetted Material "3")
— Order as 100P3xxxxY

Special (Consult representative or factory)

- Non-catalog adjustable range and/or set point, deadband and proof pressure
- Media temperature capability from -65°F to +400°F
- Chemical seals installed

Ordering Procedure

- When factory presetting is desired, stipulate set point, increasing or decreasing
- Insert available option number or letter designation as required

Example

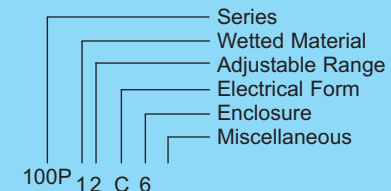

Envelope Dimensions

Adjustable
Range 1

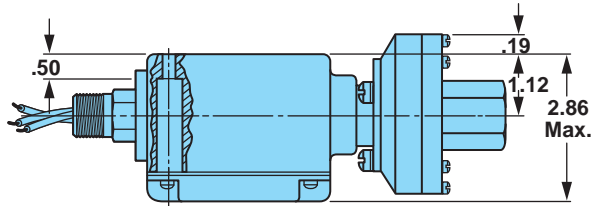

Adjustable
Range 2-8

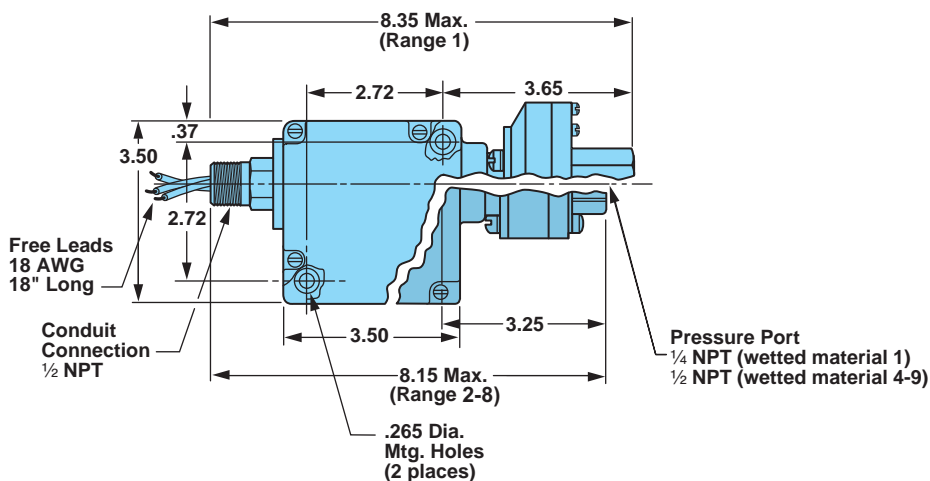
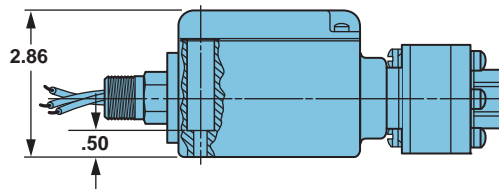

Electrical Form

FORM "C"
(SPDT)

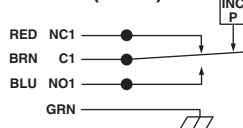

FORM "CC"
(DPDT)

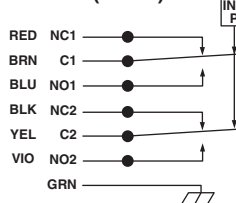

Basic Principles of Design

